

NODEMCU ESP32

Microcontroller development board

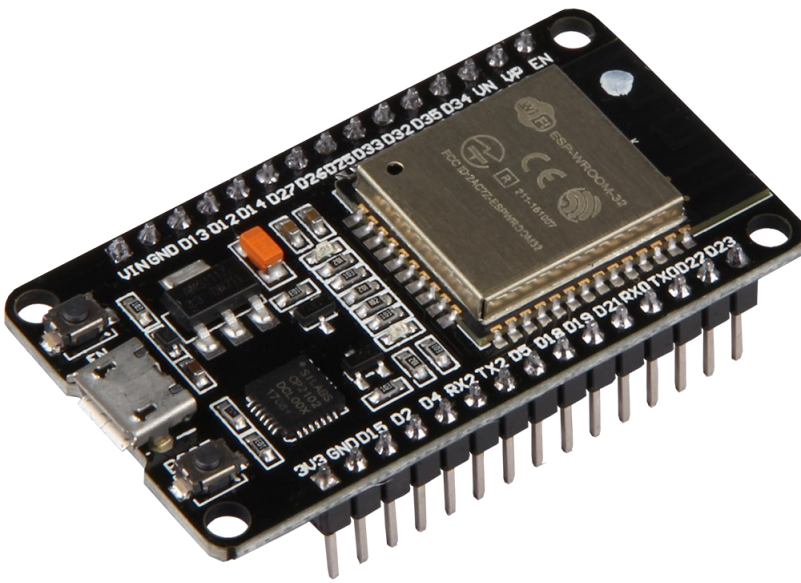

1. GENERAL INFORMATION

Dear customer,

Thank you for purchasing our product. In the following, we will show you which things should be noted during the use.

Should you encounter any unexpected problems, do not hesitate to contact us.

2. OVERVIEW

The NodeMCU ESP32 module is a compact prototyping board and is simple to program via the Arduino IDE. It has a 2.4 GHz dual mode WiFi and a BT wireless connection. Moreover, the microcontroller has integrated: a 512 kB SRAM and 4 MB memory, 2x DAC, 15x ADC, 1x SPI, 1x I²C, 2x UART. PWM is activated at all digital pins.

An overview of the pins can be found in the following picture:

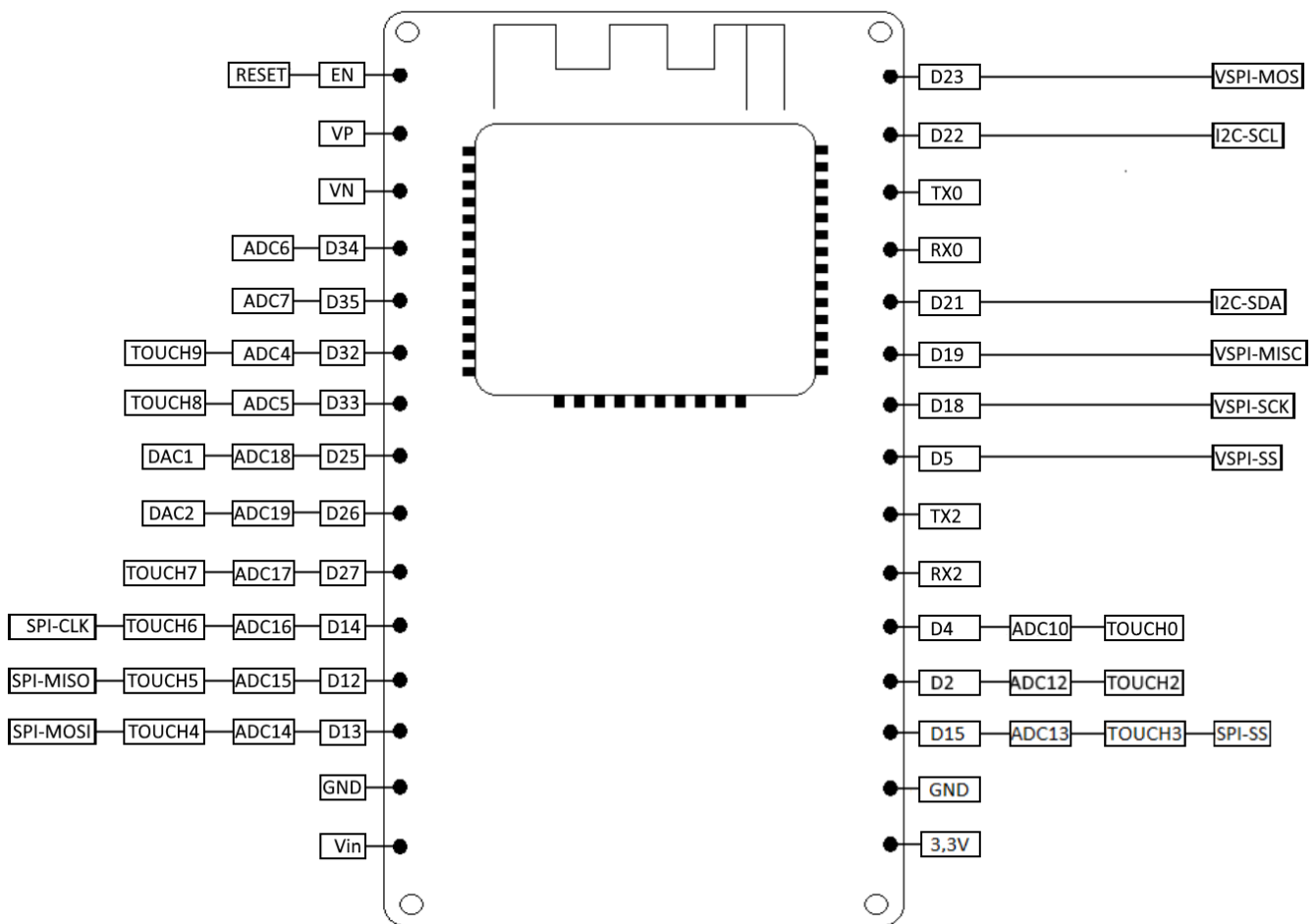

3. INSTALLATION OF THE MODULES

If [Arduino IDE](#) is not already installed on your computer, first download this program and install it. After that download the [updated CP210x USB-UART driver](#) for your operating system and install it. As the next step, you have to add a new board manager. For that follow the following instructions.

1. Click on File → Preferences

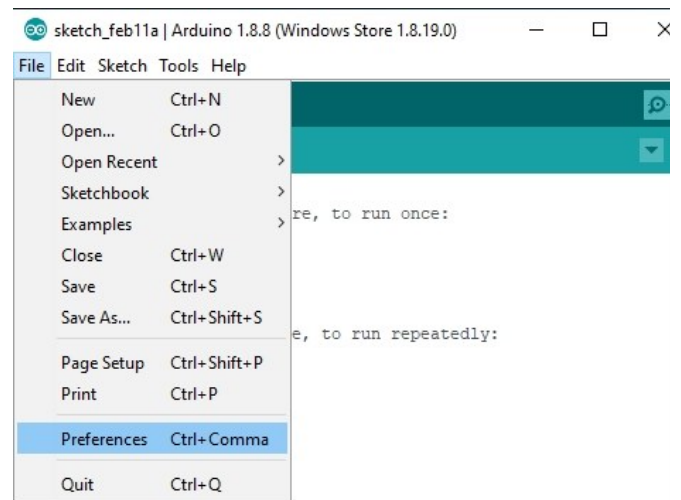

2. Add to the Additional Boards Manager URLs the following link:
https://dl.espressif.com/dl/package_esp32_index.json
You can divide multiple URLs with a comma.

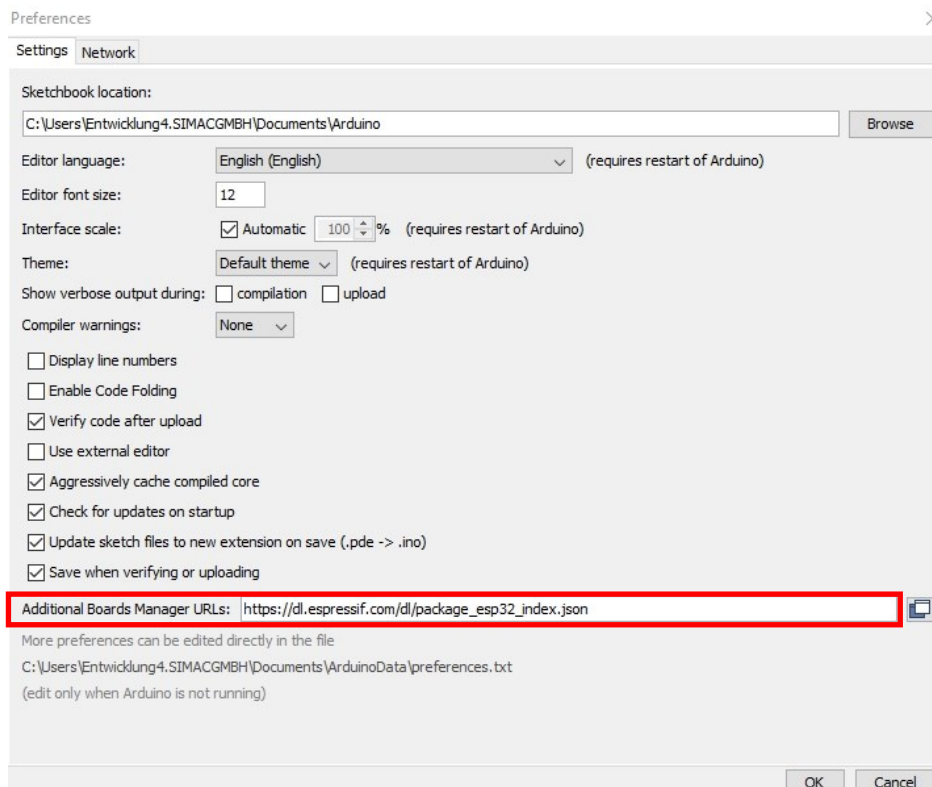

3. Now click on Tools → Board → Boards Manager...

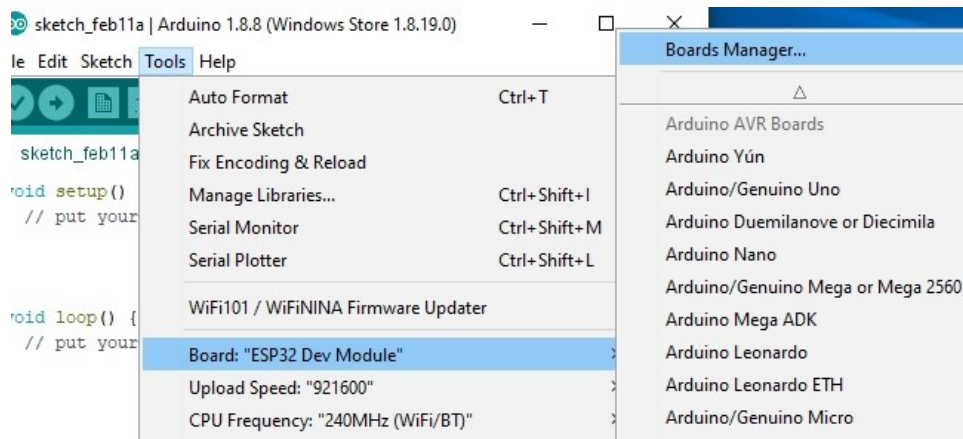

4. Install *esp32* by *Espressif Systems*.

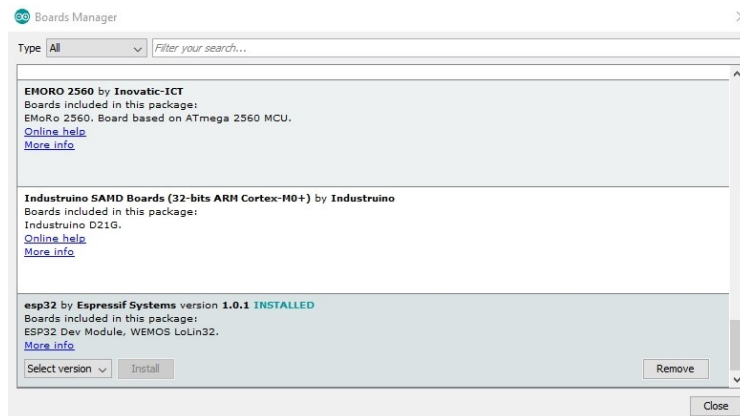

The installation is now completed. You can now choose in Tools → Board the **ESP32 Dev Module**.

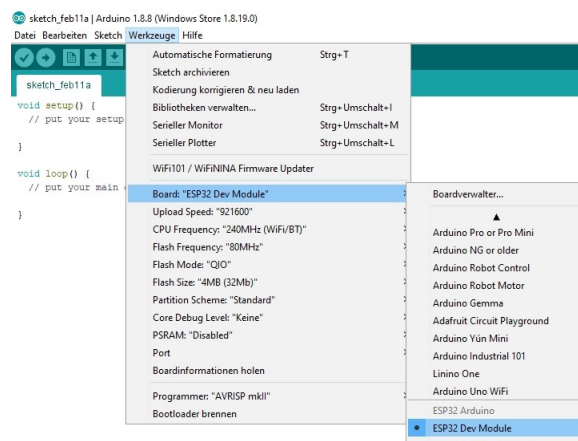

Attention! After the initial installation, the board rate may have changed to *921600*. This could cause problems. In such a case, set the baud rate to *115200* to avoid any problems.

4. USAGE

Your NodeMCU ESP32 is now ready to use. Simply connect it with an USB cable to your computer.

The installed libraries provide many examples to gain you some insight into the module.

These examples can be found in your Arduino IDE in File → Example → ESP32.

The fastest and easiest way to test your NodeMCU ESP is the recall of device number. Copy the following code or use the code example **GetChipID** from the Arduino IDE:

```
uint64_t chipid;

void setup() {
  Serial.begin(115200);
}

void loop() {
  chipid=ESP.getEfuseMac();//The chip ID is essentially its MAC address(length:6bytes)
  Serial.printf("ESP32 Chip ID = %04X", (uint16_t)(chipid>>32)); //print High 2 bytes
  Serial.printf("%08X\n", (uint32_t)chipid); //print Low 4bytes.

  delay(3000);
}
```

To upload, click on the upload button from the Arduino IDE and hold down the **BOOT** button on the SBC NodeMCU ESP32. The upload is completed until the writing has reached 100% and you will be asked to reboot (hard reset via RTS pin ...) with the **EN** key.

You can see the output of the test on the serial monitor.

5. OTHER INFORMATION

Our Information and Take-back Obligations according to the Electrical And Electronic Equipment Act (ElektroG)



Symbol on Electrical and Electronic Products:

This crossed-out bin means that electrical and electronic products do **not** belong into the household waste. You must hand over your old appliance to a registration place. Before you can hand over the old appliance, you must remove used batteries and replacement batteries which are not enclosed by the device.

Return Options:

As the end user, you can hand over your old appliance (which has essentially the same functions as the new one bought with us) free of charge for disposal with the purchase of a new device.

Small devices, which do not have outer dimensions bigger than 25 cm can be handed in for disposal independently of the purchase of a new product in normal household quantities.

1. Possibility of return at our company location during our opening hours

SIMAC Electronics GmbH, Pascalstr. 8, D-47506 Neukirchen-Vluyn

2. Possibility of return nearby

We will send you a parcel stamp with which you can send us your old appliance free of charge. For this possibility, please contact us via e-mail at service@joy-it.net or via telephone.

Information about Package:

Please package your old appliance safe for transport. Should you not have suitable packaging material or you do not want to use your own material, you can contact us and we will send you an appropriate package.

6. SUPPORT

If any questions remain open or problems may arise after your purchase, we are available by e-mail, telephone and ticket support system to answer these.

E-Mail: service@joy-it.net

Ticket-system: <http://support.joy-it.net>

Telephone: +49 (0)2845 98469 – 66 (10 - 17 o'clock)

For further information visit our website:

www.joy-it.net